

# THE NEW MAYTAG NEPTUNE® DRYER

# USER

# G U I D E

## TABLE OF CONTENTS

Safety Instructions .....	1-2
Dryer Exhaust Tips .....	3
Operating Tips.....	4
Control Panel.....	5
Controls at a Glance .....	6-14
Special Laundry Tips .....	15
Care & Cleaning .....	16
Before You Call .....	17
Accessories .....	18
Warranty .....	19
Guide de l'Utilisateur .....	20
Guía del Usuario .....	40

## Welcome

Welcome and congratulations on your purchase of a Maytag Neptune® dryer! Your complete satisfaction is very important to us. For best results, we suggest reading this material to help acquaint you with proper operating and maintenance procedures.

Should you need assistance in the future, it is helpful to:

- 1) Have complete model and serial number identification of your dryer. This is located on a data plate in the lower center of the door opening.

Date of Purchase \_\_\_\_\_

Model Number \_\_\_\_\_

Serial Number \_\_\_\_\_

- 2) **IMPORTANT: Keep this guide and the sales receipt in a safe place for future reference. Proof of original purchase date is needed for warranty service.**

If you have questions, write us (include your model, serial number and phone number) or call:

Maytag Appliances Sales Company  
Attn: CAIR® Center  
P.O. Box 2370  
Cleveland, TN 37320-2370  
1-888-462-9824 USA and CANADA  
1-800-688-2080 USA TTY  
(for deaf, hearing impaired or speech impaired)  
(Mon.–Fri., 8am–8pm Eastern Time)  
<http://www.maytag.com>

**For service and warranty information, see page 19.**

**NOTE: In our continuing effort to improve the quality of our appliances, it may be necessary to make changes to the appliance without revising this guide.**

# IMPORTANT SAFETY INSTRUCTIONS

read before operating your dryer

**⚠ WARNING:** To reduce the risk of fire, electric shock or injury to persons when using the appliance, follow basic precautions, including the following:

- 1 Read all instructions before using the appliance.
- 2 To avoid the possibility of fire or explosion:
  - a Do not dry items that have been previously cleaned in, washed in, soaked in, or spotted with gasoline, dry-cleaning solvents, other flammable or explosive substances as they give off vapors that could ignite or explode. Any material on which you have used a cleaning solvent, or which is saturated with flammable liquids or solids, should not be placed in the dryer, until all traces of these flammable liquids or solids and their fumes have been removed. There are many highly flammable items used in homes, such as: acetone, denatured alcohol, gasoline, kerosene, some liquid household cleaners, some spot removers, turpentine, waxes and wax removers.
  - b Items containing foam rubber (may be labeled latex foam) or similarly textured rubber-like materials must not be dried on a heat setting. Foam rubber materials when heated, can under certain circumstances produce fire by spontaneous combustion.
- 3 Do not allow children to play on or in the appliance. Close supervision of children is necessary when the appliance is used near children.
- 4 Before the appliance is removed from service or discarded, remove the door to the drying compartment.
- 5 Do not reach into the appliance if the drum is moving.
- 6 Do not install or store this appliance where it will be exposed to the weather.
- 7 Do not tamper with controls.
- 8 Do not repair or replace any part of the appliance or attempt any servicing unless specifically recommended in published user-repair instructions that you understand and have the skills to carry out.
- 9 Do not use fabric softeners or products to eliminate static unless recommended for dryer use by the manufacturer of the fabric softener or product.
- 10 Clean the lint screen before or after each load.
- 11 Keep the area around the exhaust opening and surrounding areas free from lint accumulation, dust and dirt.
- 12 The interior of the dryer and exhaust duct should be cleaned periodically by qualified service personnel.
- 13 This appliance must be properly grounded. Never plug the appliance cord into a receptacle which is not grounded adequately and in accordance with local and national codes. See installation instructions for grounding this appliance.
- 14 Do not sit on top of the clothes dryer.

## **I**MPORTANT SAFETY INSTRUCTIONS CONT.

**WARNING:** For your safety, the information in this manual must be followed to minimize the risk of fire or explosion or to prevent property damage, personal injury or death.

- Do not store or use gasoline or other flammable vapors and liquids in the vicinity of this or any other appliance.
- **WHAT TO DO IF YOU SMELL GAS**
  - Do not try to light any appliance.
  - Do not touch any electrical switch.
  - Do not use any phone in your building.
  - Clear the room, building or area of all occupants.
  - Immediately call your gas supplier from a neighbor's phone. Follow the gas supplier's instructions.
  - If you cannot reach your gas supplier, call the fire department.

Installation and service must be performed by a qualified installer, service agency or the gas supplier.

**WARNING:** Do not place into your dryer items that have been spotted or soaked with vegetable oil or cooking oil. Even after being washed, these items may contain significant amounts of these oils. The remaining oil can ignite spontaneously. The potential for spontaneous ignition increases when the items containing vegetable oil or cooking oil are exposed to heat. Heat sources, such as your clothes dryer, can warm these items, allowing an oxidation reaction in the oil to occur. Oxidation creates heat. If this heat cannot escape, the items can become hot enough to catch fire. Piling, stacking or storing these kinds of items may prevent heat from escaping and can create a fire hazard.

All washed and unwashed fabrics that contain vegetable oil or cooking oil can be dangerous. Washing these items in hot water with extra detergent will reduce, but will not eliminate, the hazard. Always use the "cool down" cycle for these items to reduce the items' temperature. Never remove these items from the clothes dryer hot or interrupt the drying cycle until the items have run through the "cool down" cycle. Never pile or stack these items when they are hot.

**SAVE THESE INSTRUCTIONS**

# DRYER EXHAUST TIPS

**WARNING:** Plastic or nonmetal flexible duct presents a potential fire hazard.

## Do

Read the installation instructions and the user's guide.

## DON'T

Let a poor exhaust system cause slow drying.

## Do

Let your dryer exhaust the air easily.

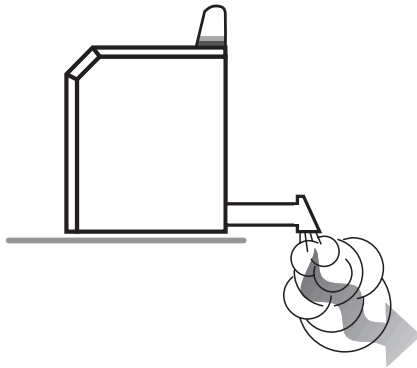

## DON'T

Restrict your dryer with a poor exhaust system.

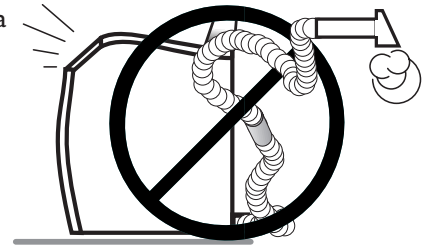

## Do

Use 4 inch diameter rigid metal duct. Tape all joints, including at the dryer. Never use lint-trapping screws.

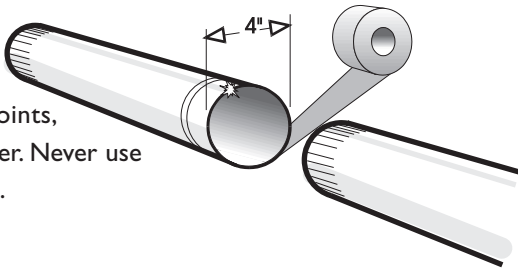

## DON'T

Use plastic, thin foil, or non-metal flexible duct.

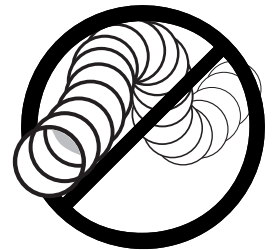

## Do

Keep duct runs as straight as possible.

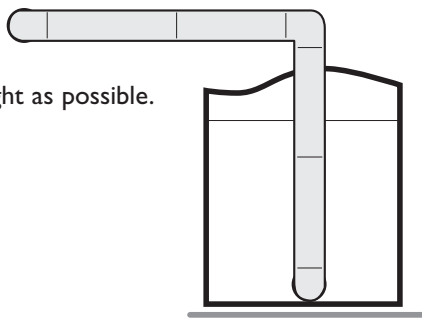

## DON'T

Use longer than necessary duct runs with many elbows.

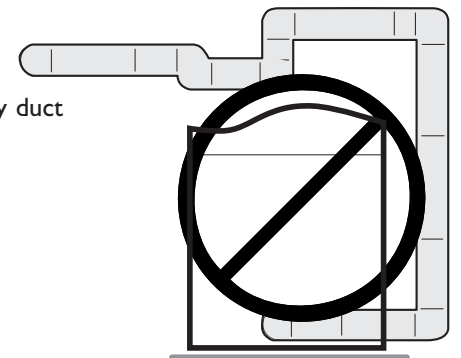

## Do

Clean all old ducts before installing your new dryer. Be sure vent flap opens and closes freely. Inspect and clean the exhaust system annually.

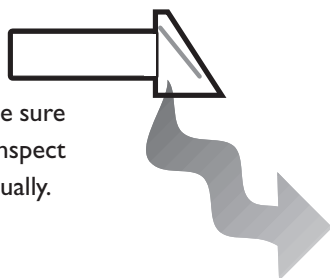

## DON'T

Allow crushed or clogged ducts and vent.

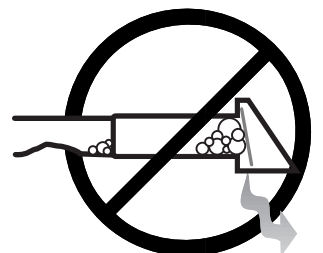

## OPERATING TIPS

### CLEAN THE LINT FILTER

- After each load.
- To shorten drying time.
- To operate more energy efficiently.

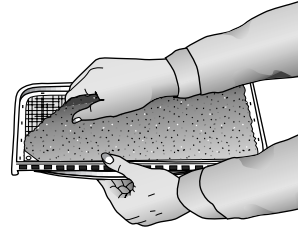

**NOTE:** Do not operate the dryer without the lint filter in place.

### LOAD THE DRYER PROPERLY

- By placing only one wash load in the dryer at a time.
- Avoid very small loads or mixing heavyweight and lightweight clothes.
- When only one or two articles need drying, add a few similar items to improve tumbling and drying efficiency.
- When drying large, bulky items such as a blanket or comforter, it may be necessary to reposition the load during the cycle to ensure even drying.

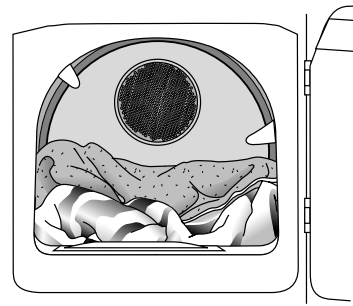

### ADD A FABRIC SOFTENER SHEET (IF DESIRED)

- After loading the dryer.
- To control static cling.
- Before the load becomes warm. This helps prevent greasy-looking softener stains.
- And remove any used softener sheets from the dryer to prevent greasy-looking softener stains.

# CONTROL PANEL

**Touchscreen** - An interactive display that responds with the touch of a finger.

**Note:** Exposure of the touchscreen to direct sunlight is not recommended.

**Home** - Takes you immediately to the first screen.

**Off** - Stops the dryer and turns off the display.

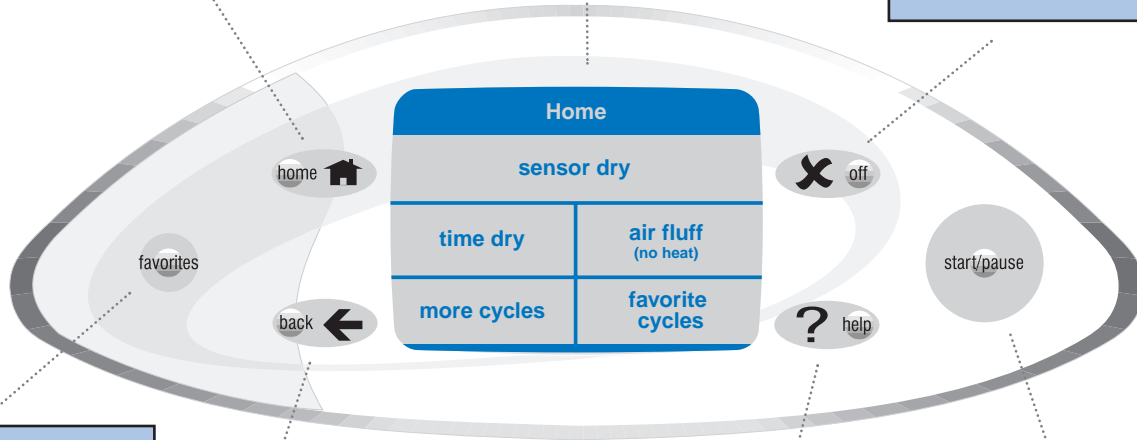

**Favorites** - Quick access to your named cycles.

**Back** - Takes you to the previous screen.

**Help** - Quick access to Before You Call, Laundering Hints, Operating Tips, Lock Out and Select Preferences.

**Start/Pause** - Press this pad to start a cycle. Once started, pressing this pad will stop the dryer at any point in the cycle.

**Special Note:** As you use the touchscreen, if you feel you are lost, press **Back** or **Home**.

# CONTROLS AT A GLANCE

## SETTING YOUR DRYER CONTROLS

If there are no words on the touchscreen, open the door, touch any pad (except off), or touch the screen to “wake” the controls.

### SENSOR DRY

Sensor dry is the fastest and most energy efficient drying method.

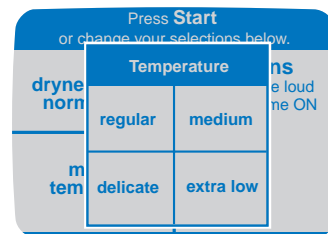
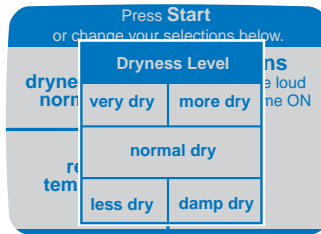
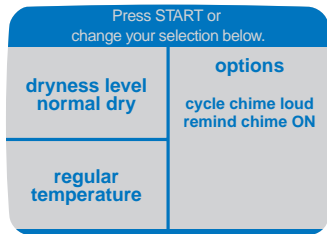
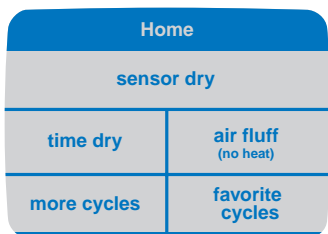

### Step 1

Select “**Sensor Dry**”. The next screen will be the Review Screen. If the selections are correct, press **Start/Pause**. If changes need to be made, follow the next steps.

### Step 2

Select dryness level. The dryness level ranges from very dry to damp dry. Select the level appropriate for the load. The “**Normal Dry**” level will be used for most loads.

### Step 3

Select appropriate temperature; “**Regular**”, “**Medium**”, “**Delicate**” or “**Extra Low**”.

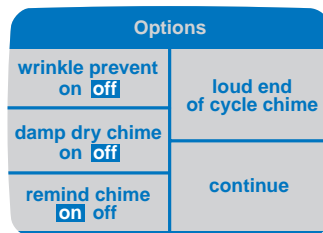
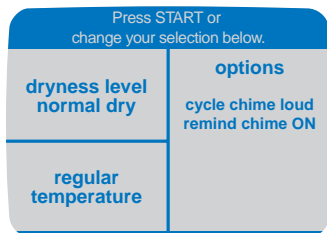

### Step 4

**Review Screen** – The Review Screen lists the selected settings. At this point you may press **Start/Pause** to begin drying the load or select “**Options**” for further customization of the drying cycle.

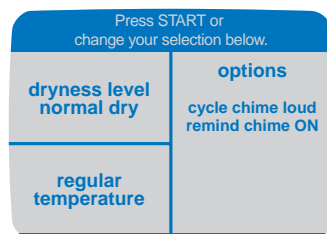

### Step 5

Selecting Options. The following options are available:

- “**Wrinkle Prevent**” - Intermittent tumble in room temperature air for up to two hours following the dry cycle.
- “**Damp Dry Chime**” - Chimes when load is damp.
- “**Remind Chime**” - Chimes at the end of the cycle every 5 minutes for up to two hours.
- “**End of Cycle Chime**” - Chimes once when the selected dryness level is reached.

### Step 6

**Review Screen** – The review screen will show once again to verify your selections. If they are correct, press **Start/Pause**. If they are incorrect, press the area you would like to change.

**Special Note:** As you use the touchscreen, if you feel you are lost, press **Back** or **Home**.

# CONTROLS AT A GLANCE CONT.

## TIME DRY

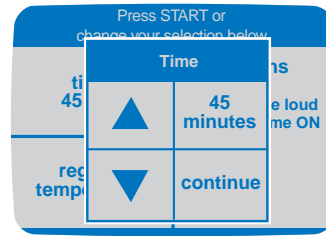
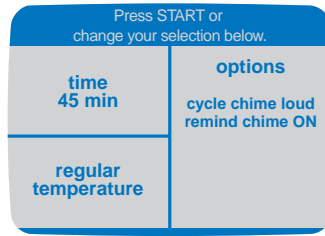
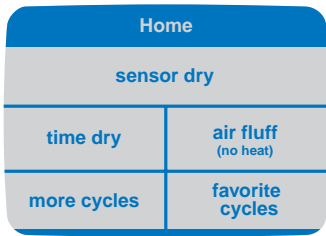

### Step 1

Select “Time Dry” from the Home screen. The control defaults to 45 minutes.

### Step 2

Press the up and down arrows to set the appropriate number of minutes to dry the load. The time will increase or decrease in five minute increments. Press “Continue”.

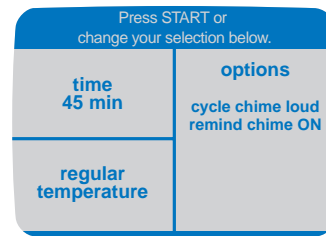
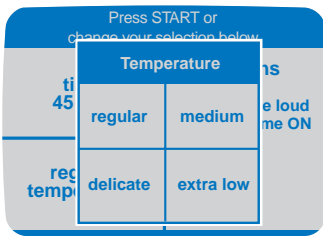

### Step 3

Select the temperature. Choose the appropriate temperature for drying the load.

### Step 4

**Review Screen** – The Review Screen lists the selected settings. At this point you may press **Start/Pause** to begin drying the load or select “Options” for further customization of the drying cycle.

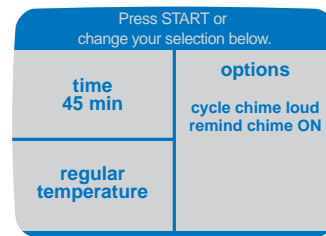
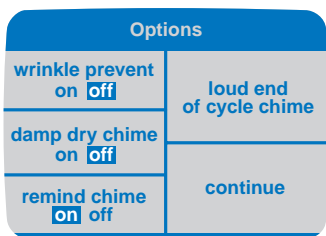

### Step 5

Selecting Options. The following options may be added to customize your Time Dry Cycle:

- “Wrinkle Prevent”
- “Damp Dry Chime”
- “Remind Chime”
- “End of Cycle Chime”

### Step 6

**Review Screen** – The review screen will show once again to verify your selections. If they are correct, press **Start/Pause**. If they are incorrect, press the area you would like to change.

**Special Note:** As you use the touchscreen, if you feel you are lost, press **Back** or **Home**.

## FAVORITES AT A GLANCE

Favorites allows you to create, name and save up to 24 commonly used drying cycles.

“Blue jeans” and “towels” favorite cycles have been programmed for you. To change these cycles for your preferences, see Edit a Favorite on page 9.

## CREATE A FAVORITE

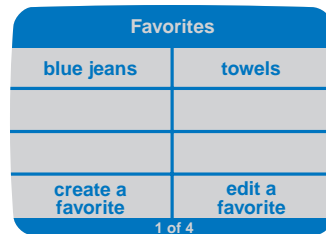
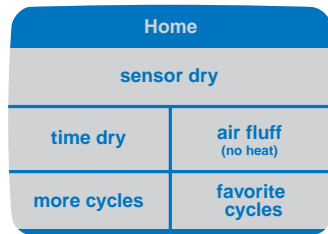

### Step 1

Touch the **Favorites** pad on the control panel or the “Favorite Cycles” area on the Home screen.

### Step 2

Touch “Create A Favorite”.

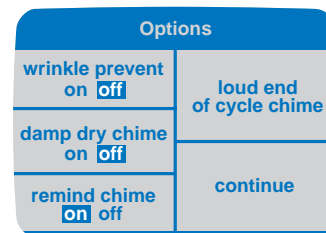
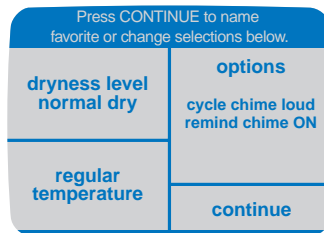
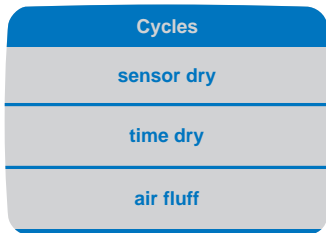

### Step 3

Select the appropriate settings for the favorite you would like to create.

### Step 4

**Review Screen** – This screen reviews your cycle choices, and allows you to choose Options to further customize your cycle. Press “Options” if desired, or press “Continue”.

### Step 5

**Options Screen** – The option choices on the left turn the options on or off. The option choices on the right show an additional screen with multiple choices. When the desired selections are made, touch “Continue” to see the review screen once again.

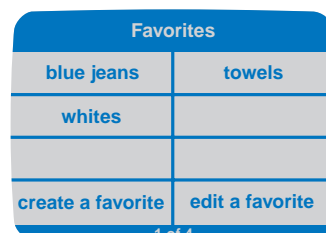
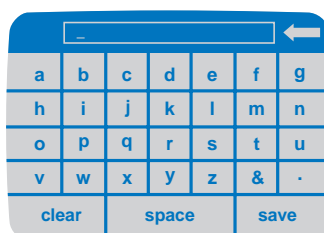
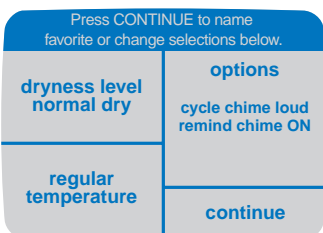

### Step 6

Press “Continue” to name your favorite cycle.

### Step 7

**Name A Favorite Cycle** – Touch the corresponding letter and space combination to spell out your favorite cycle name, up to 12 characters. Use the arrow at the top of the screen to backspace. Press “Save”.

### Step 8

Your new Favorite Cycle will now be displayed on the Favorites page.

# CONTROLS AT A GLANCE CONT.

## EDIT A FAVORITE

This function allows you to change part of a favorite cycle you already have named. You can change the current name of a favorite, change certain settings of a current favorite cycle or move a favorite to the first page.

## CHANGING THE NAME OF A FAVORITE CYCLE

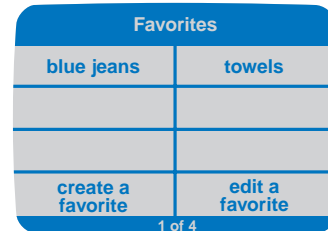
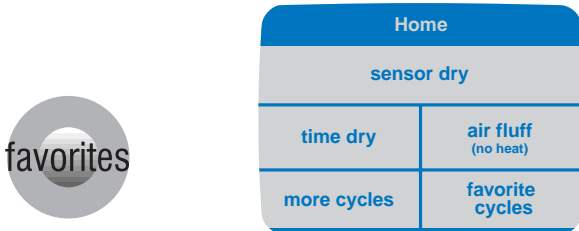

### Step 1

Either touch the **Favorites** pad on the control panel or the “Favorite Cycles” area on the Home screen.

### Step 2

Touch “**Edit A Favorite**”.

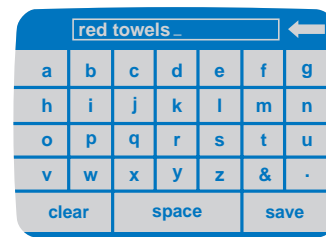
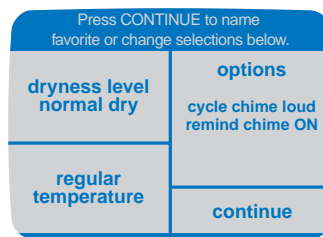
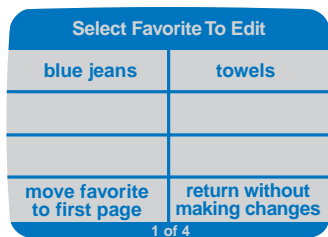

### Step 3

Touch the favorite cycle name you would like to change.

### Step 4

Touch “**Continue**”.

### Step 5

Type in the new name and press “**Save**”. Use the arrow at the top of the screen to backspace.

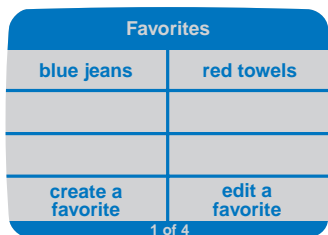

### Step 6

Press the desired favorite cycle name to start the cycle, or press the **Home** pad to return to the Home screen.

**Special Note:** As you use the touch-screen, if you feel you are lost, press **Back** or **Home**.

## CHANGING SETTINGS OF A CURRENT FAVORITE

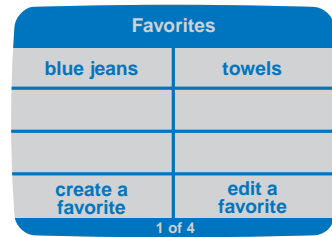
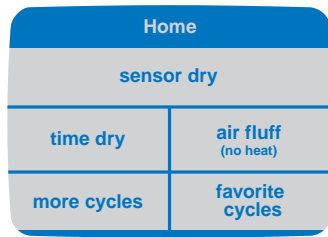

### Step 1

Either touch the **Favorites** pad on the control panel or the “**Favorite Cycles**” area on the Home screen.

### Step 2

Touch “**Edit A Favorite**”.

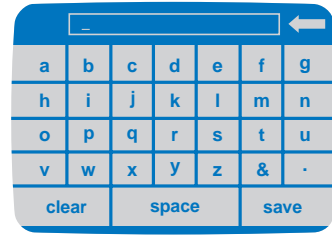
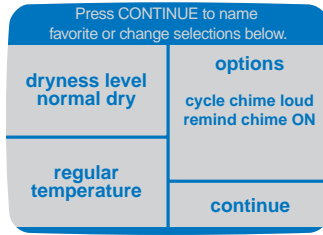
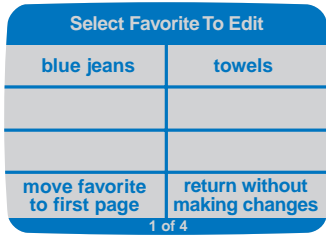

### Step 3

Touch the favorite cycle you would like to edit.

### Step 4

Make the needed changes to the cycle by touching the appropriate setting. Once you have made the adjustments, touch “**Continue**”.

### Step 5

If the current favorite cycle name still applies, just touch “**Save**”. If you prefer a new name, type in the new name and press “**Save**”.

## MOVE A FAVORITE CYCLE

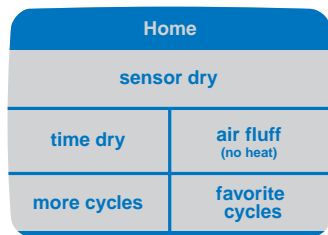

### Step 1

Either touch the **Favorites** pad on the control panel or the “**Favorite Cycles**” area on the Home screen.

### Step 2

Touch “**Edit A Favorite**”.

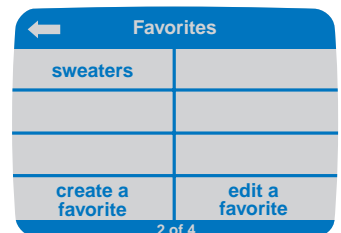
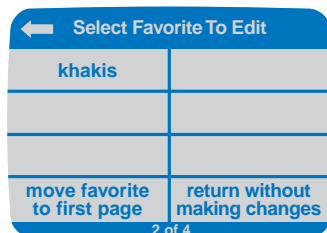
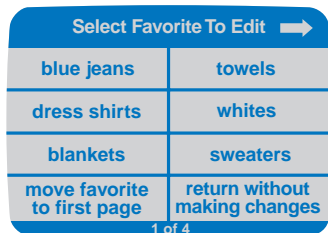

### Step 3

Touch the area entitled “**Move Favorite to First Page**”. Using the arrow at the top, scroll through the pages until you get to the favorite you would like to move to the first page. Touch that favorite cycle.

### Step 4

The favorite cycle you selected to move will now be in the upper left position of the touchscreen. The other favorite cycles moved back one position with the sixth favorite cycle moving to the next page of favorites.

**Note:** Use the arrow at the top of the screen to scroll from page to page.

# CONTROLS AT A GLANCE CONT.

## USING HELP

The Help feature offers a variety of detailed information including before you call, laundry hints, dryer operating tips, lock out feature and select preferences.

## BEFORE YOU CALL



### Step 1

Touch the **Help** touchpad.

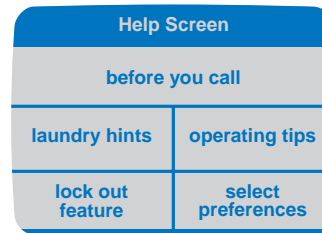

### Step 2

Select "**Before You Call**".

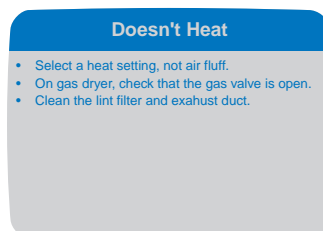

### Step 3

Here you will see headings for common trouble-shooting topics. Touch one of the displayed areas to see specific information. For more detailed information, see "Before You Call" section, pg. 17, or call 1-888-462-9824 for further assistance.

### Step 4

If you would like to see the other topics, just press the **Back** touchpad button to get back to the main topics.

**Special Note:** As you use the touchscreen, if you feel you are lost, press **Back** or **Home**.

# LAUNDERING HINTS



Help Screen	
before you call	
laundry hints	operating tips
lock out feature	select preferences

## Step 1

Touch the **Help** touchpad.

## Step 2

Select “Laundry Hints”.

Laundry Hints	
dryer add.	dryer sorting
lint filter	line dry
items to avoid	dry rack
dry special	washer hint

Dryer Additives
fabric softener sheets
Dryel

Fabric Softener Sheets →
<ul style="list-style-type: none"><li>• Fabric softener sheets reduce static cling and soften clothes as the dryer heats.</li><li>• Use one fabric softener sheet per load.</li><li>• Do not reuse fabric softener sheets.</li><li>• If spotting occurs, dampen the spot and rub with a bar of Ivory™ soap. Re-laundry using warm water.</li><li>• Fabric softener sheets are not recommended for use on children's sleepware or garments labeled flame</li></ul>

← Fabric Softener Sheets
resistant as they may reduce flame resistance.

## Step 3

The Laundry Hints screen displays the available topics. Touch the headings to see specific information for each topic and sub-topic. For more information, see “Special Laundry Tips” section, pg. 15, or call 1-888-462-9824 for further assistance.



## Step 4

If you would like to see the other topics, just press the **Back** touchpad button to get back to the main topics.

**Note:** Use the arrow at the top of the screen to scroll from screen to screen.

# CONTROLS AT A GLANCE CONT.

## OPERATING TIPS



### Step 1

Touch the **Help** touchpad.

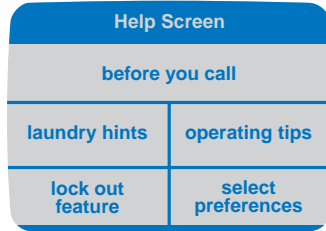

### Step 2

Select “**Operating Tips**”.

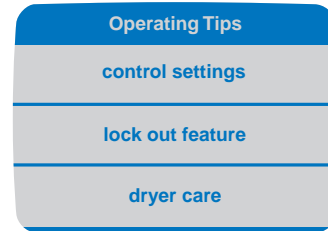

### Step 3

“**Operating Tips**” provides information on maximizing the touchscreen controls and use of your dryer. Touch the headings to see specific information for each topic.



### Step 4

If you would like to see the other topics, press the **Back** touchpad button to get back to the main topics.

## LOCK OUT FEATURE



### Step 1

Touch the **Help** touchpad.

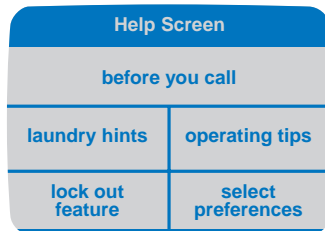

### Step 2

Select “**Lock Out Feature**”.

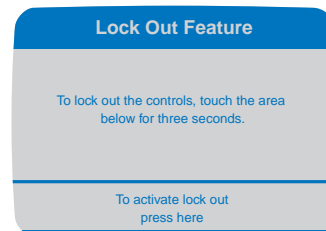

### Step 3

The “**Lock Out Feature**” deactivates the touchscreen and touchpads. Use this feature for cleaning the control panel or to prevent unwanted use of the dryer.



### Step 4

If you would like to see the other topics, just press the **Back** touchpad button to get back to the main topics.

## SELECT PREFERENCES

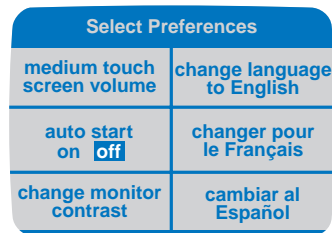
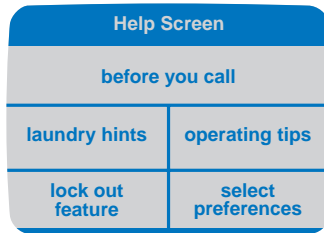

### Step 1

Touch the **Help** touchpad.

### Step 2

Select **“Select Preferences”**.

### Step 3

**“Select Preferences”** allows you to select the volume of the touchscreen beeps, set the intensity of the screen display, activate Auto Start and change the display language from English to French or Spanish. Touch the headings to change the settings.

## TOUCHSCREEN VOLUME

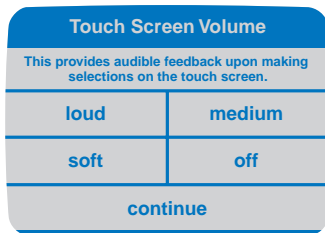

Touch **“Loud”**, **“Medium”**, **“Soft”** or **“Off”** to set the volume level of the touchscreen beeps. Touch **“Continue”** to accept the selected volume setting.

## AUTO START

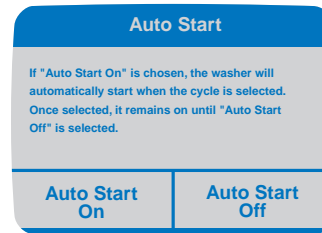

When **“Auto Start On”** is chosen, the dryer will automatically start when the cycle is selected.

## CHANGE MONITOR CONTRAST

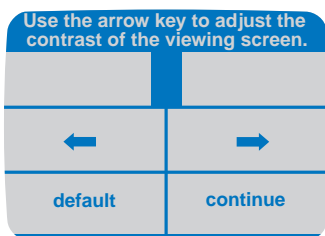

Depending on the lighting in your home and other factors, you may want to adjust the intensity of your touchscreen. Touch the arrows to lighten or darken the display. Touch **“Continue”** when finished.

## CHANGE LANGUAGE



You have the ability to change the language between English, French and Spanish. You will always see the next screen in the selected language to make sure you want to change the language.



### Step 4

If you would like to see the other topics, just press the **Back** touchpad button to get back to the main topics.

# SPECIAL LAUNDRY TIPS

Please follow the care label or manufacturer's instructions for drying special items. If care label instructions are not available, use the following information as a guide.

## Bedspreads & Comforters

- Follow the care label instructions or dry using the Sensor Dry cycle.
- Be sure the item is thoroughly dry before using or storing.
- May require repositioning to ensure even drying.

## Blankets

- Dry only one blanket at a time for best tumbling action.
- Be sure the item is thoroughly dry before using or storing.

## Curtains & Draperies

- Use Sensor Dry cycle and the extra low temperature setting to help minimize wrinkling.
- Dry these in small loads for best results and remove as soon as possible.

## Cloth Diapers

- Use Sensor Dry and the regular temperature setting for soft, fluffy diapers.

## Down-filled Items

(jackets, sleeping bags, comforters, etc.)

- Use Sensor Dry and the extra low temperature setting.
- Place a clean pair of sneakers in the dryer with the item to fluff the down comforters, etc. Adding a couple of dry towels shortens dry time and absorbs moisture.

## Foam Rubber

(rug backs, stuffed toys, shoulder pads, etc.)

- DO NOT dry on a heat setting. Use Air Fluff option (no-heat).
- WARNING – Drying a rubber item with heat may damage it or be a fire hazard.

## Pillows

- Use Sensor Dry.
- Add a couple of dry towels and a pair of clean sneakers to help the tumbling action and to fluff the item.
- DO NOT dryer-dry kapok or foam pillows.

## Plastics

(shower curtains, outdoor furniture covers, etc.)

- Use Air Fluff or Time Dry and the extra low temperature setting depending on the care label instructions.

## AVOID DRYER DRYING

- Fiberglass Items (curtains, draperies, etc.)
- Woolens, unless recommended on the label.
- Vegetable or cooking oil soaked items. (See pg.2)

## CARE AND CLEANING

**Control Panel** – clean with a soft, damp cloth. Do not use abrasive substances. Do not spray cleaner directly on the panel.

**Tumbler** – remove any stains such as crayon, ink pen or fabric dye (from new items such as towels or jeans) with an all-purpose cleaner. Then tumble old towels or rags to remove any excess stain or cleaning substance. Once these steps are done, stains may still be visible, but should not transfer to subsequent loads.

**Cabinet** – wipe off any marks with soap and water.

**Dryer Exhaust System** – should be inspected and cleaned once a year to maintain optimum performance. The outside exhaust hood should be cleaned more frequently to ensure proper operation. (Refer to the Installation Instructions for more information.)

## REPLACE DRUM LIGHT

### Instructions for replacing the bulb:

- 1) Unplug or disconnect the dryer from the electrical power supply.
- 2) Open the door and use a Phillips screwdriver to remove the screw attaching the lens to the tumbler front.
- 3) Remove lens cover by pulling cover toward center of tumbler.
- 4) Rotate bulb counter-clockwise to remove from socket.
- 5) Replace the bulb with a 120 volt, 10 watt maximum candelabra base light bulb.
- 6) Turn the light bulb clockwise into socket.
- 7) Replace lens cover by hooking plastic tabs into tumbler front below the light housing.
- 8) Reinstall the screw into the lens cover screw hole.
- 9) Reconnect dryer to power supply.

## REVERSE THE DOOR

### Directions for reversing the dryer door.

- 1) Remove the hinge hole covers and screws.
- 2) While supporting the door, remove 2 screws in the hinges that secure the hinges to the cabinet.
- 3) Remove door by lifting slightly at the hinges and pulling the hinge tabs out of the hinge slots.
- 4) Move the following parts to the opposite side of the door: 2 hinges and 4 hinge screws, 4 door screws, door strike and screw, inner door cover plate and screw.
- 5) Attach the door to the opposite side of the cabinet using the 2 counter sunk hinge screws. (See below). Screw the lower hinge screw in first. This will help to align the door and hinges.
- 6) Replace the hinge hole covers to the opposite side.

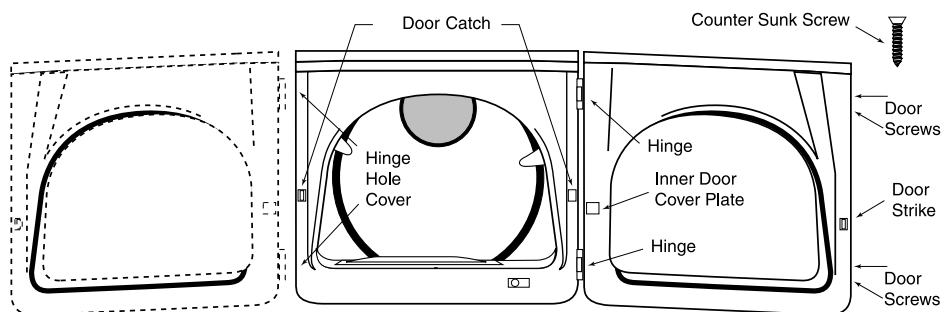

**CHECK THESE POINTS IF YOUR MAYTAG NEPTUNE® DRYER...**

**Doesn't Run**

- Be sure the door is latched shut.
- Be sure the power cord is plugged into a live electrical outlet.
- Check the home's circuit breaker and fuses.
- Press the Start/Pause button again if the door is opened during the cycle.

**Doesn't Heat**

- Check the home's circuit breaker and fuses.
- Select a heat setting, not air fluff.
- On a gas dryer, check that the gas supply is on.
- Clean the lint filter and exhaust duct.
- Dryer may have moved into the cool-down portion of the cycle.

**Doesn't Dry**

- Check all of the above, plus...
- Be sure the exhaust hood at the outside of the home can open and close freely.
- Check exhaust system for lint build-up. Ducting should be inspected and cleaned annually.
- Use 4" rigid metal exhaust duct.
- Do not overload. 1 Wash load = 1 Dryer load.
- Sort heavy items from lightweight items.
- Large, bulky items like blankets or comforters may require repositioning to ensure even drying.
- Check that the washer is draining properly to extract adequate water from the load.
- Clothes load too small to tumble properly. Add a few towels.

**Is Noisy**

- Check the load for objects such as coins, loose buttons, nails, etc. Remove promptly.
- It is normal to hear the dryer gas valve or heating element cycle on and off during the drying cycle.
- Be sure the dryer is leveled properly as outlined in the installation manual.
- Be sure the rubber feet are installed on the leveling legs.
- It is normal for the dryer to hum due to the high velocity of air moving through the dryer drum and exhaust system.

**Dries Unevenly**

- Seams, pockets and other similar heavy areas may not be completely dry when the rest of the load has reached the selected dryness level. This is normal. Select the "Very Dry" setting if desired.
- If one heavy item is dried with a lightweight load, such as one towel with sheets, it is possible that the heavy item will not be completely dry when the rest of the load has reached the selected dryness level. Sort heavy items from lightweight items for best drying results.

**Has an Odor**

- Household odors such as from painting, varnishing, strong cleaners, etc. may enter the dryer with the surrounding room air. This is normal as the dryer draws the air from the room, heats it, pulls it through the tumbler and exhausts it to the outside. When these odors are present in the air, ventilate the room completely before using the dryer.

**For further assistance, call Maytag Customer Service toll-free at 1-888-4-MAYTAG (1-888-462-9824). U.S. customers using TTY for deaf, hearing impaired or speech impaired, call 1-800-688-2080.**

## D RYING ACCESSORIES

A drying rack is available for items that you don't want to tumble dry; such as sneakers, washable sweaters, stuffed toys or pillows, etc. See your Maytag dealer for details, or call 1-800-688-8408 to order.

**Part No. MAL1000AXX**

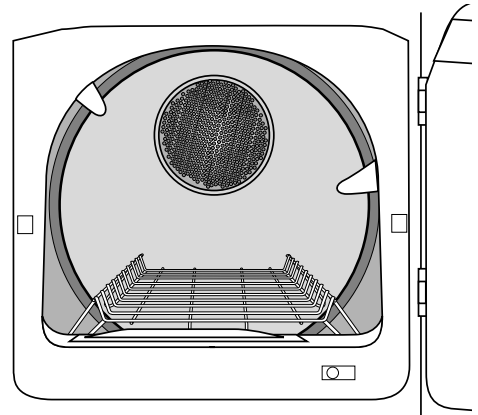

# CLOTHES DRYER WARRANTY

## Full One Year Warranty

For one (1) year from the date of original retail purchase, any part which fails in normal home use will be repaired or replaced free of charge.

## Limited Warranty

After the first year from date of original retail purchase, through the time periods listed below, the parts designated below which fail in normal home use will be repaired or replaced free of charge for the part itself, with the owner paying all other costs, including labor, mileage and transportation.

**Second Year** – All parts.

**Third Through Fifth Year** – Dryer tumbler, electronic controls.

## Additional Limited Warranty Against Rust-Through

Should an exterior cabinet, including the door, rust through during the one year period starting from the date of retail purchase, repair or replacement will be made free of charge. After the first and through the tenth year, repair or replacement will be made free of charge for the part itself, with the owner paying all other costs, including labor, mileage and transportation.

**Please Note:** This full warranty and the limited warranties apply when the dryer is located in the United States or Canada. Dryers located elsewhere are covered by the limited warranties only, including parts which fail during the first two years.

## Canadian Residents

This warranty covers only those dryers installed in Canada that have been listed with Canadian Standards Association unless the dryers are brought into Canada due to transfer of residence from the United States to Canada.

The specific warranties expressed above are the **ONLY** warranties provided by the manufacturer. This warranty gives you specific legal rights, and you may also have other rights that vary from state to state.

## To Receive Warranty Service

To locate an authorized service company in your area contact the Maytag dealer from whom your appliance was purchased; or call Maytag Appliances Sales Company, Maytag Customer Assistance at the number listed below. Should you not receive satisfactory warranty service, please call or write:

Maytag Appliances Sales Company  
Attn: CAIR® Center  
P.O. Box 2370  
Cleveland, TN 37320-2370

**U.S. or Canada (toll-free) 1-888-462-9824**

**U.S. customers using TTY for deaf, hearing impaired or speech impaired, call 1-800-688-2080.**

When contacting Maytag Appliances Sales Company, Maytag Customer Assistance about a service problem, please include the following:

- (a) Your name, address and telephone number;
- (b) Model number and serial number (found on the lower center of the door opening) of your appliance;
- (c) Name and address of your dealer and the date the appliance was purchased;
- (d) A clear description of the problem you are having.
- (e) Proof of purchase.

## What is not covered by these warranties:

1. Conditions and damages resulting from any of the following:
  - a. Improper installation, delivery, or maintenance.
  - b. Any repair, modification, alteration or adjustment not authorized by the manufacturer or an authorized servicer.
  - c. Misuse, abuse, accidents, or unreasonable use.
  - d. Incorrect electric current, voltage or supply.
  - e. Improper setting of any control.
2. Warranties are void if the original serial numbers have been removed, altered, or cannot be readily determined.
3. Light bulb
4. Products purchased for commercial or industrial use.
5. The cost of service or service call to:
  - a. Correct installation errors.
  - b. Instruct the user on proper use of the product.
  - c. Transport the appliance to the servicer.
6. Consequential or incidental damages sustained by any person as a result of any breach of these warranties.

Some states do not allow the exclusion or limitation of consequential or incidental damages, so the above exclusion may not apply.

User's Guides, service manuals and parts catalogs are available from Maytag Appliances Sales Company, Maytag Customer Assistance.